

Whole Field Spatial Frequency Analysis of Double-or Multiple-exposed PIV Images

Kawahashi, M.*¹, Kamimura, Y.*² and Hirahara, H.*¹

*1 Department of Mechanical Engineering, Saitama University, Urawa, Saitama, 338-8570 Japan.

*2 Fuji Heavy Industries Ltd., Ohta, Gunma, 373 Japan.

Received 23 March 1998.

Revised 25 July 1998.

Abstract: Speckle Velocimetry or high-image density PIV gives a velocity vector map of a two-dimensional flow field by point-by-point spatial frequency analysis of local pattern at an interrogation spot in a double- or a multiple-exposed image of laser speckle or pseudo-speckle pattern generated by pulsed laser-light-sheet illuminations of a plane in the flow densely seeded with fine particles. The whole field spatial frequency analysis of the double- or multiple-exposed PIV image gives more useful information of the flow field. Optical Fourier transform is a conventional technique not only for the local spatial frequency analysis but for the whole field analysis. Filtering of spatial frequency is one of the typical techniques for the latter which can reconstruct a velocity contour or a component velocity contour map of the flow. Fundamentally this technique is a simple and efficient analogue method to get more information in the velocity field analysis of the flow than a digital image processing, but in practical applications the measurement is restricted to simple flows because of optical noise and low spatial resolution. In order to improve the technique, the fundamental characteristics of the filtering and the noise yielded in the filtering process must be investigated. Meanwhile, wavelet analysis can also be applied to the whole field spatial frequency analysis of PIV image. In this paper the filtering technique is examined by numerical convolution integral, and the results obtained are compared with ones obtained by the wavelet analysis.

Keywords: speckle velocimetry, PIV, Fourier transform, spatial frequency filtering, wavelet analysis.

1. Introduction

Speckle velocimetry (SV) or high-image-density PIV on the basis of velocity reduction from a double- or a multiple-exposed image of laser speckle pattern or dense particle distribution pattern (pseudo-speckle pattern) is a well-established technique for two-dimensional measurement of an instantaneous velocity field of a fluid flow. The practical process of this method is as follows. In order to take the double- or multiple-exposed image, the fluid densely seeded with fine particles is illuminated twice or several times by a thin sheet of pulsed laser light within a short-time interval between pulses. The velocity vector diagram of the flow field is reduced by point-by-point spatial frequency analysis at an interrogation spot in the image. Furthermore, the whole field spatial frequency analysis of the double- or the multiple-exposed image can reconstruct a velocity contour or a component velocity contour map of the flow field. The latter is the merit of the technique, and it gives useful information to understand the aspect of the flow field. These processes are irrespective of whether the image obtained is the laser speckle pattern or the pseudo-speckle pattern.

Photographic film is commonly used for recording the laser speckle or the pseudo-speckle pattern on account of high resolution. In this case, optical Fourier transform is an efficient technique for both of the local and the whole field analysis of spatial frequency. Optical spatial frequency filtering is usually used for the whole field

analysis. Though a digital processing can also be applied to reduce velocity field from the multiple-exposed PIV image, the reason why the optical method has been applied is that the resolution of photographic image used to be lost in the conversion process of a photographic image to a digital image. However, the merits of use of the photographic film and the analogue processing are overturning by the recent developments of recording devices, such as high resolution CCD camera and high resolution film scanner, and of high functional PC. Then a digital processing of high-image-density patterns of speckle or pseudo-speckle without destroying resolution has been established. Hence the total processing time of composing a velocity vector diagram in SV or high-image-density PIV by point-by-point analysis can be shortened by digital processing. However the optical spatial frequency filtering is still more efficient for the whole field analysis than the digital processing. This technique can be accomplished by using simple optical system, and it realizes a real time processing theoretically. Meynart (1979) first applied the spatial frequency filtering technique in the velocity field measurement of fluid flows to obtain a velocity contour map of Benard convection. After that this technique was applied to an internal gravity wave by Gartner et al. (1986), a convection in a liquid by Meynart et al. (1987), a Couette flow by Narumi et al. (1988), and some types of flow by the author (Suzuki et al., 1983; Kawahashi et al., 1986). Digital filtering on the basis of numerical convolution integral was presented by Grant & Qiu (1990). However, this technique has not been developed as the practical method in fluid flow measurement, because the accuracy and the spatial resolution of measurement are suppressed by optical noise appearing in the filtering process. An additional post processing in the filtering technique for improvement of the accuracy and the spatial resolution has been proposed by Palero et al. (1995).

This paper describes the fundamental characteristics of the whole field spatial frequency analysis of the double- or the multiple-exposed PIV images investigated numerically in order to develop it as a practical method in fluid flow measurements. The filtering technique by numerical convolution and the wavelet analysis are applied in this spatial frequency analysis. The wavelet analysis is recently paid attention as a new technique of visualized image analysis (e.g., Okuno et al., 1996). However the application of the wavelet analysis for the spatial frequency analysis of the multiple-exposed PIV image to reconstruct spatial frequency contour map has not been reported. In this paper, the spatial frequency filtering by numerical convolution for some type filters and the continuous wavelet analysis are carried out for some multiple-exposed PIV images produced synthetically and obtained experimentally. And the characteristics of the images after analyses by both techniques are presented.

2. Method

In SV or high-image-density PIV, the local velocity vector is obtained by measurement of displacement vector of a local pattern at an interrogation spot in a double- or a multiple-exposed image instead of tracking an individual particle image. The displacement vector at the interrogation spot is determined from the primary peak position of the auto-correlation function calculated on the local pattern at the spot. The calculation of auto-correlation function is carried out by using Fourier transform as follows.

$$f(x,y)*f^*(x,y) = \int_{-\infty}^{\infty} \int_{-\infty}^{\infty} f(x',y')f^*(x'-x,y'-y)dx'dy'$$

$$\mathcal{F}\{f(x,y)*f^*(x,y)\} = \left| F(v_x, v_y) \right|^2 \quad \left[F(v_x, v_y) = \mathcal{F}(f(x,y)) \right] \quad (1)$$

$$\Rightarrow f(x,y)*f^*(x,y) = \mathcal{F}^{-1} \left(\left| F(v_x, v_y) \right|^2 \right)$$

where $f(x,y)*f^*(x,y)$ is the auto-correlation function of the local image function $f(x,y)$, $f^*(x,y)$ is the complex conjugate of $f(x,y)$, \mathcal{F} and \mathcal{F}^{-1} indicate Fourier transform and inverse Fourier transform. The process can be practiced both optically and numerically. The optical processing to calculate the auto-correlation function is separated into two steps. The optical system using in each step consists of a laser light source, a lens, and a screen. In the first step, an interrogation spot in the image recorded on the film is irradiated by a laser beam. Then an image after Fourier transform by the lens is produced on the screen placed at the focal plane of the lens (Fourier plane) as an intensity distribution of absolute value of spatial frequency. In the second step, the inverse Fourier transform of the image obtained in the first step is performed, and then an image corresponding to the intensity distribution of auto-correlation function of the original image is produced on the screen. The distance and the

direction from the origin to the primary peak of the auto-correlation function determine the local displacement vector at the interrogation spot in the original image. This processing is performed efficiently by FFT of digital image data converted from an original image. In order to keep high resolution of the original image in the process, a high resolution film scanner (e.g., Cannon CanoScan 2700F, 8bit, $2,588 \times 3,886$ pixels/frame, 2720 dpi) is used for the image acquisition to a computer.

The spatial frequency filtering is a typical example of optical computing. The mathematical principle of the filtering is the convolution of the image function with the impulse response of a spatial frequency filter function. The convolution integral is executed by translating into Fourier transform and inverse transform as following mathematical description.

$$f(x,y) \otimes h(x,y) = \int_{-\infty}^{\infty} \int_{-\infty}^{\infty} f(x',y') h(x'-x, y'-y) dx' dy'$$

$$\mathcal{F}\{f(x,y) \otimes h(x,y)\} = F(v_x, v_y) \cdot H(v_x, v_y) \quad (2)$$

$$\therefore f(x,y) \otimes h(x,y) = \mathcal{F}^{-1}\{F(v_x, v_y) \cdot H(v_x, v_y)\}$$

where \otimes indicates the convolution calculation,

$$F(v_x, v_y) = \mathcal{F}(f(x,y)), \quad H(v_x, v_y) = \mathcal{F}(h(x,y))$$

$H(v_x, v_y)$: spatial frequency filter

$h(x,y)$: impulse response of the filter

The optical system of the filtering technique is shown in Fig. 1. When the whole field of the original image is irradiated by parallel light, its Fourier transform pattern is produced on the screen at the focal plane of the first lens. Then Fourier transform of the transmitted light through the filter produces an image on the screen placed at the focal plane of the second lens. The image after filtering appears in the contour lines of spatial frequency with integral multiples of fundamental filtering frequency, which are corresponding to the contour map of the displacements. The filtering with a pinhole filter gives a contour map of the component of displacements in a direction, which is coincident with the direction to the pinhole from the optical axis. An annulus filter, which is corresponding to a narrow band-pass filter, gives a contour map of the absolute value of displacements.

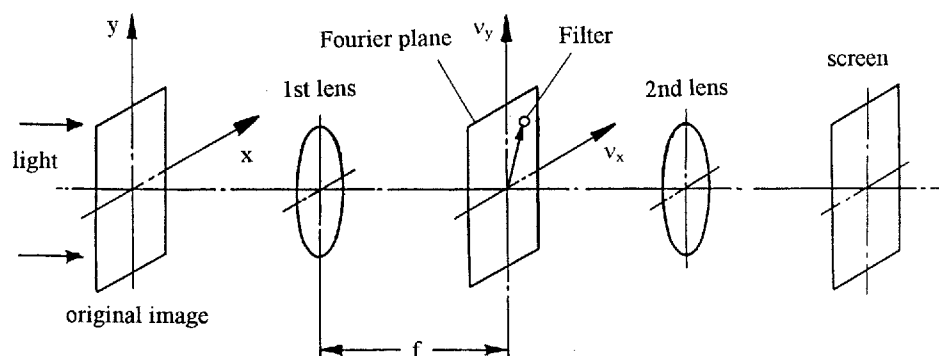

Fig. 1. Optical arrangement of spatial frequency filtering.

An example of the images after spatial frequency filtering obtained experimentally is shown in Fig. 2. This figure shows the images after pinhole filtering corresponding to contour maps of x - and y -component velocities of the wake flow of a circular cylinder at $Re \approx 380$ by Kawahashi et al. (1986). Generally S/N ratio of the image after filtering is very low as shown in this figure. The possibility of improvement of this method for practical use in fluid flow measurements is investigated here by using a numerical simulation technique. In practice, the multiplying of a filter function with an image after Fourier transform of synthetic multiple-exposed patterns of

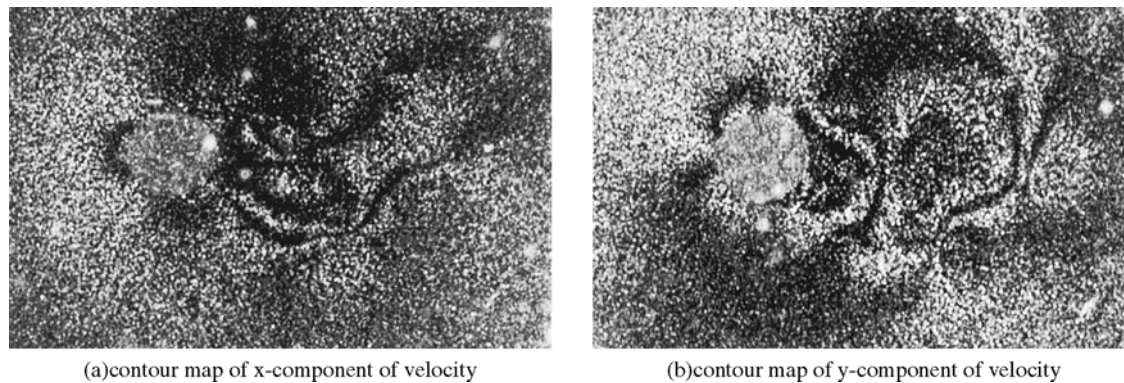

Fig. 2. Images after filtering of a wake flow of a circular cylinder. (Kawahashi, M. et al., 1986)

flows is calculated in the frequency space, then an image after filtering is obtained by the inverse Fourier transform of the product. The numerical procedure is practiced by using an FFT routine of MATLAB.

In the wavelet analysis, the whole field spatial frequency analysis of the double- or the multiple-exposed PIV image can be performed directly in position/spatial frequency domain. The continuous wavelet analysis is applied here to obtain component velocity contour maps to compare the results obtained by filtering technique. The procedure of wavelet analysis is based on following equations.

$$c(a, \mathbf{b}) = \frac{1}{\sqrt{a}} \int_{-\infty}^{\infty} f(\mathbf{x}) \psi \left(\frac{\mathbf{x}-\mathbf{b}}{a} \right) d\mathbf{x}$$

$$\mathbf{b} = (b_x, b_y), \quad \mathbf{x} = (x, y) \tag{3}$$

$$\psi(x, y) = e^{-\frac{x^2+y^2}{2}} \begin{bmatrix} e^{-i\Omega x} & -e^{-\frac{\Omega y}{2}} \end{bmatrix}$$

where a is scale parameter, \mathbf{b} is vector of translation parameter, \mathbf{x} is position vector, $f(\mathbf{x})$ is image function, ψ is mother wavelet function, and $\Omega = 2\pi$, respectively.

3. Results

The whole field spatial frequency analyses of the synthetic PIV images corresponding to a rotational flow and a Couette flow are performed by the filtering technique and the wavelet analysis. Three types of filters, such as a pinhole filter, a slit filter and an annulus filter, are used in the spatial frequency filtering. In the case of spatial frequency analysis with the pinhole filter, the extracted central-spatial-frequency, which includes the horizontal and the longitudinal component frequencies, v_x and v_y , is determined by the position vector of the pinhole in the spatial frequency domain. By the annulus filter, the constant absolute value of spatial frequency distributing along a circle $\sqrt{v_x^2+v_y^2}$ is extracted. The characteristics of the slit filter is similar to the pinhole filter, and it can be used in the case that the vector direction of primary spatial frequency in the image is coincide with the direction to the slit from the origin of spatial frequency plane.

As the first example, the spatial frequency filtering of a standard image corresponding to a rotational flow at constant angular velocity by using an annulus filter is carried out to verify the fundamental characteristics of the technique to obtain a contour map of equi-spatial-frequency. The synthetic pattern, the filter, and the image after filtering are shown in Fig.3. The number density of particle images and the multiplicity of the pattern record are parameters for constructing the synthetic images. The original image is 512×512 pixels in size and 8 bit in gray level. The particles sized with 5×5 pixels are regularly distributed with constant intervals in radial and circumferential directions as illustrated in Fig.3 (a). The individual particle image and the annulus filter are formed using a Gaussian distribution to avoid the edge effect in Fourier transform. In this case, the filtered image predicted theoretically is a contour map with concentric circles. The calculated contour lines of the spatial frequency are clearly distinguishable and close to the theoretical prediction as shown in Fig. 3(c).

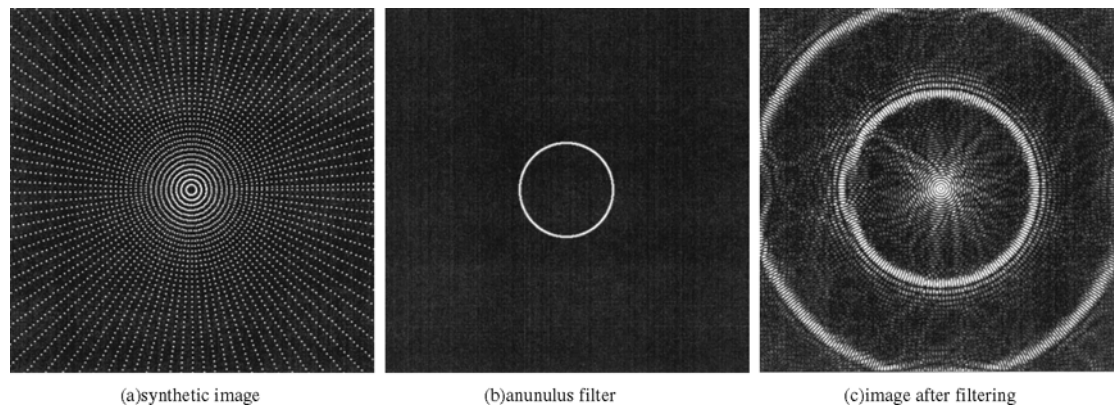

Fig. 3. Spatial frequency filtering of a standard image corresponding to a rotational flow.

Synthetic multiple-exposed PIV images of a rotational flow at constant angular velocity, in which the particle images are distributed randomly, are applied to the spatial frequency filtering. The double-exposed image with 5,000 particles and the octet-exposed image are shown in Figs. 4 (a-1) and (b-1), respectively. The sizes of the whole image and the individual particle image, the intensity distribution of the particles and of the filter are in accordance with the former case shown in Fig. 3. The filtered image predicted theoretically must be the same pattern with the former case. The contour lines in the image after filtering of the double-exposed image are not clear due to unexpected noise yielding in the whole region as shown in Fig. 4 (a-2). In the case of octet-exposure, the contrast of the contour lines in the image is improved as shown in Fig. 4 (b-2). The difference in contrast of the filtered image is considered by power spectrum diagrams of the images shown in Figs. 5 (a) and (b). Though the

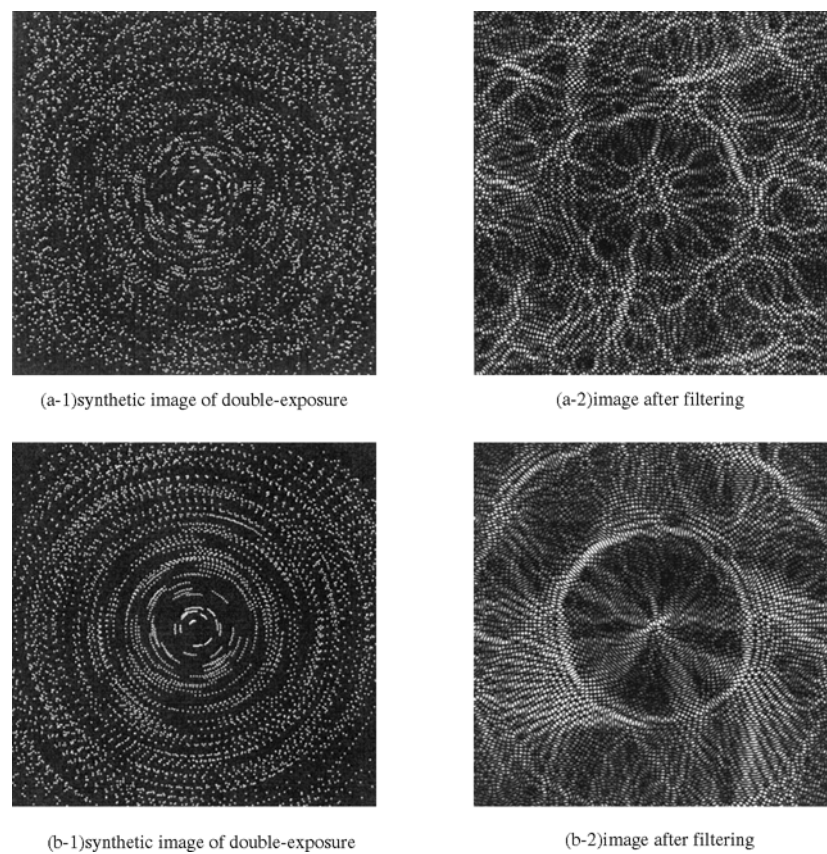

Fig. 4. Spatial frequency filtering of a synthetic image corresponding to multiple-exposed PIV image of a rotational flow.

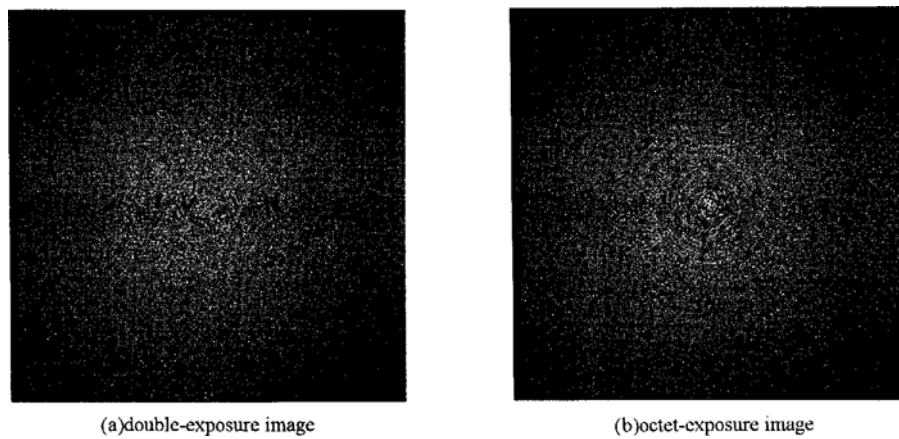

Fig. 5. Power spectrum diagrams of synthetic images shown in Fig. 4.

power spectrum of the double-exposure image decreases monotonously with increase of spatial frequency, in the case of the octet-exposed image, the distinctive spectra appear in circular distribution.

The filtering by using a pinhole filter produces a contour map of equi-component frequency. The contour map is also produced by the wavelet analysis based on Eq.(3). Figure 6 shows the image after filtering with a pinhole filter on x -component spatial frequency in the octet-exposed image shown in Fig. 4 (b-1) and the result of the wavelet analysis for the same component frequency. The pinhole filter is consisted of a pair of pinholes in symmetry with respect to the origin of the frequency space. The theoretical pattern in this processing is parallel lines with constant interval. The calculated pattern obtained by both techniques are formed in trains of spots on the lines predicted theoretically. It is considered that the image density in the x direction is not enough high. The resolution of the contour lines obtained by the wavelet analysis is little higher than by the filtering.

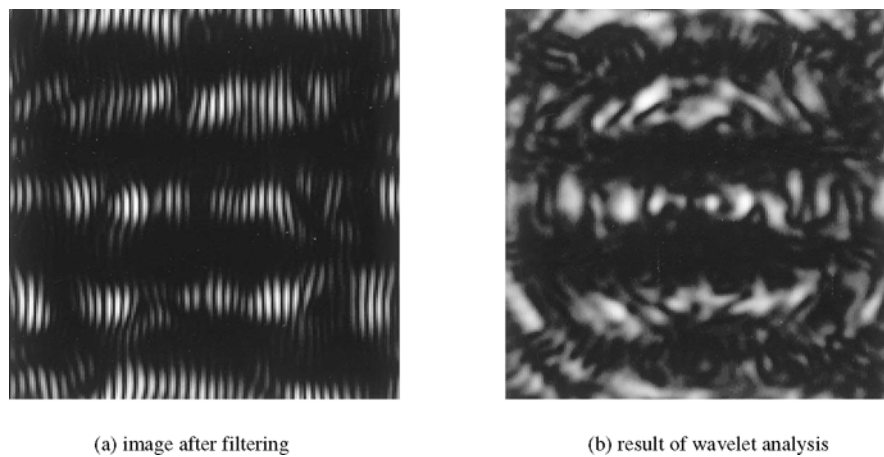

Fig. 6. Images obtained by filtering method with pinhole filter and by wavelet analysis.

As the second example, the whole field spatial frequency analysis of a synthetic PIV image corresponding to a Couette type flow is attempted. The original image, in which the maximum displacement is 16 pixels at the lower end and the upper end is at rest, is an octet-exposed pattern consisted of 5,000 particles distributed randomly. In the filtering technique, the pinhole and the annulus filters are used. The original image and the filters are shown in Fig. 7. The results obtained by the filtering and by the wavelet analysis are shown in Fig. 8. These must be given rise to the same pattern of contour map in parallel lines. The filtered images with both type filters shown in Figs.8 (a) and (b) show different characteristics. The filtering with the pinhole produces less noise but indistinct image. On the other hand the image obtained with the annulus filter is much noisier than the image by the pinhole filter, but the contour map is distinguishable as parallel lines. The results obtained by the wavelet analysis show that the contrast of the contour line of higher order frequency is less than the result by the filtering as shown in Fig. 8 (c).

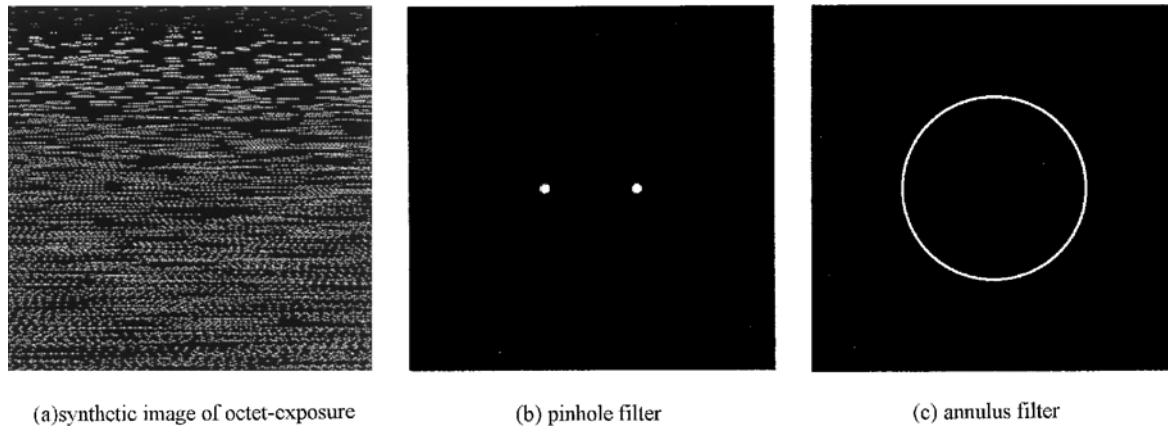

Fig. 7. Synthetic image corresponding to a Couette flow and filters.

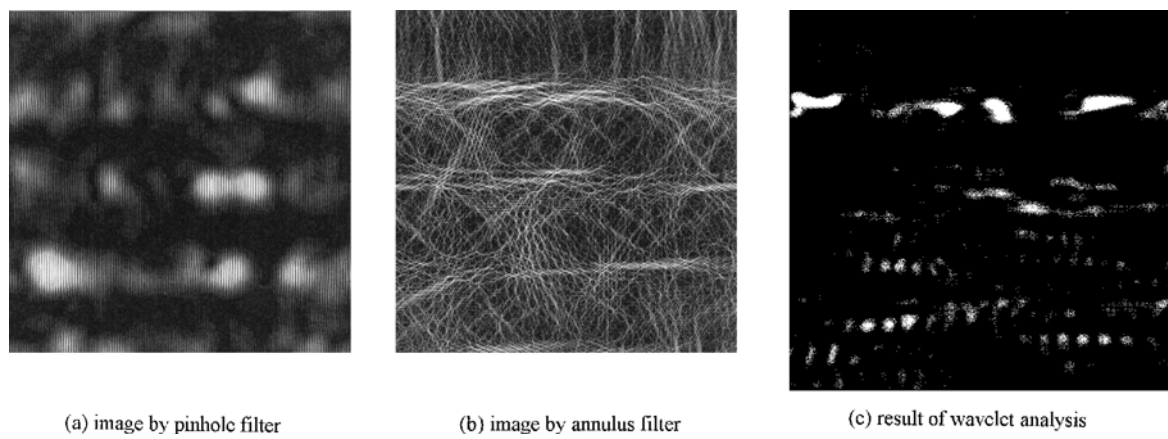

Fig. 8. Images obtained by filtering method and by wavelet analysis.

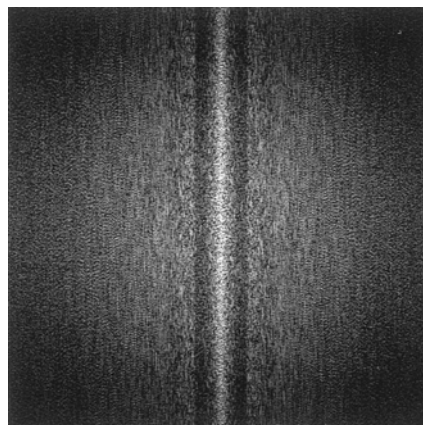

Fig. 9. Power spectrum diagram of synthetic image of Couette flow.

The dominant component spatial frequency including the image shown in Fig. 7 is the horizontal component v_x , and the component in the longitudinal direction distributes in wide band as shown in Fig. 9. In the case, a slit filter is suitable for the spatial frequency filtering. The filter used and the image after filtering are shown in Fig. 10. The parallel contour lines appear clearly as shown in the figure. Consequently, in the case of an uni-directional flow, the spatial frequency filtering on the multiple-exposed PIV image of the flow with the slit filter is efficient.

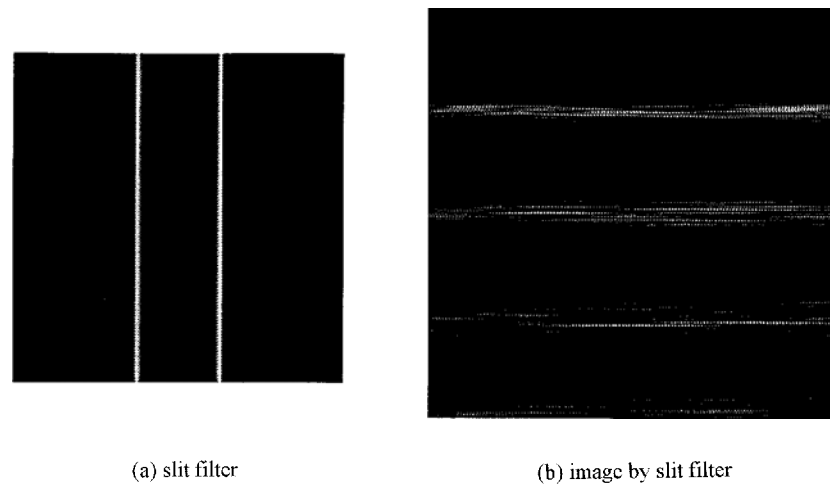

Fig. 10. Slit filter and image after filtering with slit filter.

As an example of a practical application, a multi-exposed image of a combined flow of thermal convection with acoustic streaming produced in a horizontal closed duct is applied to spatial frequency analysis. The flow field, presented by Kawahashi et al. (1995), is produced by superimposing an acoustic standing wave to a natural convection generated by heating of the lower wall of the duct. The multi-exposed image of the flow seeded with fine particles is recorded on a photographic film by repeated illumination with pulsed laser-light-sheet. The image is transformed into a digital image by making use of high resolution film scanner ($2,588 \times 3,886$ pixels/frame) for the filtering and the wavelet analysis. The original image obtained experimentally and the results of spatial frequency analysis are shown in Fig. 11. Figures 11 (b) and (c) show the contour maps of the longitudinal component spatial frequency of 8 pixels. The equi-component-velocity line is clearly reconstructed in both figures. The contrast of the images obtained by both techniques is in similar level but the spatial resolution in the case of the wavelet analysis is a little higher than the filtered image.

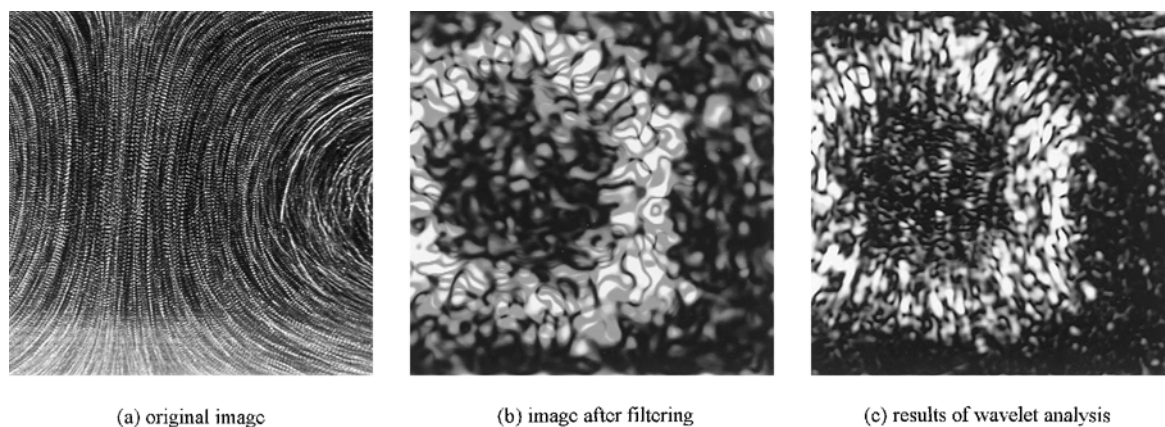

Fig. 11. Spatial frequency analysis of multiple-exposed image of a flow generated by coupling of natural convection with acoustic streaming.

4. Conclusions

The fundamental characteristics of the spatial frequency filtering and the continuous wavelet analysis on the double- or the multiple-exposed PIV image were investigated by numerical simulation in order to improve the technique of the whole field spatial frequency analysis for practical use in fluid flow measurements. The concluding remarks are as follows.

1. for the multiple-exposed PIV image of which the image density and the multiplicity are high enough, there is

possibility that the spatial frequency filtering method under suitable selection of the filter is able to be a practical technique to reconstruct equi-velocity contour maps which can give useful information to understand the aspect of the flow field. The finding out of the proper filter is predicted by the frequency spectrum of the original PIV image.

2. in the spatial frequency analysis by filtering technique, for the moment, the optical analogue method is efficient than the numerical convolution because of insufficient information in the calculation due to the limit of resolution of the digital image.
3. the wavelet analysis can be applied to the whole field spatial frequency analysis of the multi-exposed PIV image as well as the spatial frequency filtering technique, but high resolution of spatial frequency can not be realized.

Acknowledgments

We would like to express our gratitude sincerely to Prof. T. Okuno of Osaka Prefecture University for his appropriate advice on the wavelet analysis on visualized images.

References

- Gärtner, U., Wernekinch, U. and Merzkirch, W., Velocity Measurements in the Field of an Internal Gravity Wave by Means of Speckle Photography, *Exp. Fluids*, 4 (1986), 283-287.
- Grant, I. and Qiu J. H., Digital Convolution Filtering Techniques on an Array Processor for Particle Image Velocimetry, *Appl. Optics*, 29 (1990), 4327-4329.
- Kawahashi, M., Toyooka, S., Hosoi, K. and Suzuki, M., Speckle Method for Velocity Measurement and Visualization of Flow, *Flow Visual. IV*, Hemisphere Publishing Corp., Washington (1986), 139-143.
- Meynart, R., Flow Velocity Measurement by a Speckle Method, 2nd Cong. Optics Appl. Metrology, SPIE-210 (1979), 25-28.
- Narumi, A., Kashiwagi, T., Sato, K. and Sakata, M., Measurement and Visualization of a Two-dimensional Velocity Distribution by Laser Speckle Photography Using a He-Ne Gas Laser (2nd report), *Trans. JSME(B)*, 54 (1988) 1994-2001. (in Japanese)
- Okuno, T., Image Analysis with 2-D Wavelet Transform -An Application to Flow Visualization Image -, *Proc. Korea-Japan Workshop on Ship Hydrodynamics* (1996).
- Parelo, V., Andrés, N., Arroyo, M. P. and Quintanilla, M., Fast Quantitative Processing of Particle Image Velocimetry Photographs by a Whole-Field Filtering Technique, *Exp. Fluids*, 19 (1995), 417-425.
- Suzuki, M., Hosoi, K., Toyooka, S. and Kawahashi, M., White-Light Speckle Method for Obtaining an Equi-Velocity Map of a Whole Flow Field, *Exp. Fluids*, 1 (1983), 79-81.
- Kawahashi, M., Tanahashi, M., Arakawa, M. and Hirahara, H., Visualization and Measurement of Acoustic Streaming Coupling with Natural Convection, *ASME, FED-229*, (1995), 281-300.

Authors' Profiles



Masaaki Kawahashi: He received his MSc (Eng) degree in mechanical engineering in 1968 from University of Electro-Communication, and his D.Eng. in 1978 from the University of Tokyo. After MSc he worked as Research Assistant, a Lecturer, and an Associate Professor at Saitama University before taking up his current position as a Professor at Saitama University. His research interests in thermo-fluid phenomena induced by finite amplitude wave motion in ducts, speckle metrology, and PIV measurements of complicated flow field like in centrifugal fan.



Yoshio Kamimura: He received his MSc (Eng) degree in mechanical engineering from Saitama University. He is working in automobile body design section at Fuji Heavy Industries.



Hiroyuki Hirahara: He received his master degree in mechanical engineering in 1983 from Kyusyu University, and his doctor degree in engineering in 1986 from Kyushu University. After the doctor course, he worked in atomic power plant engineering section in Toshiba Co. Ltd. He Worked as an Assistant and a Lecturer of Saitama University, before taking up his current position. He is an Associate Professor of Saitama University, and his research subjects are high speed flow, supersonic flow with condensation or evaporation, flow measuring techniques, optical measurement techniques and environmental fluid mechanics.